

SETTING NEW  
STANDARDS



**HYPER  
GRINDER**

**HYPER  
FLAT  
FLOOR**

Planer/ Grinder for flooring with Laser system to assist the grinding of **CLS** flooring in order to reach requirements of flatness needed for the safe operation of **VNA** forklifts.



MADE IN ITALY

# FAST, ACCURATE, RELIABLE, PROFITABLE

## HG HYPER GRINDER REDEFINES THE METHOD OF PLANING INDUSTRIAL FLOORS WITH A LASER SYSTEM.

VIDEO



LASER GRINDER - ROLLER

LASER GRINDER - PLANETARIUM

PLANER FLOOR

The modern logistic warehouses with high capacity and narrow lanes (VNA), need a paving with almost perfect flatness; In fact, the trilateral trolleys would not be able to move easily in height if continually shaken by the unevenness of the floor.

A traditional industrial floor is not suitable for this type of warehouse.

The unevenness of the floor can frequently cause serious safety problems, decelerations in the handling of goods, and, in some cases, a total block.

### TECHNICAL DATA

	Engine	Volt	Hertz	Amp	Working section mm	Overall dimensions with roller LxAxP cm	Overall dimensions with planer LxAxP cm
HG Laser Grinder	22 Kw	400	50/60	32	max 400	220x75x165	400x75x165

# HYPER FLAT FLOOR



The alignment for "narrow corridors", is up to only 1650mm wide and up to 16 meters of height, allowing a very high density of storage of goods, as well as an optimal speed for flow of storage.

High efficiency is possible thanks to the almost "surgical" precision of the forklifts created for this specific use.

However, it should be remembered that the flooring is the work plan on which all logistic activities are carried out, therefore VNA trolleys must operate on a flooring with the correct characteristics required. There isn't enough importance given to the characteristic requirements of flooring, and to the tolerance for bearing the weight of the shelves. Apart from discovering once the site is completed that the beautiful Trolleys cannot move on a traditional type of flooring.

**HG HYPER GRINDER** introduces the new **HYPER FLAT FLOOR** planer/Grinder with automatic levelling with a Laser system that allows to obtain the perfect evenness for the lanes suitable to operate VNA trolleys.

## HYPER FLAT FLOOR GRINDER

has been specifically designed to work in an operating warehouse, in order to not cause even the slightest inconvenience for the clients workers. HYPER FLAT FLOOR GRINDER is able to do the planing of the floor both dry and with water and does not release dust in the environment and can work even in the presence of shelves with full loads of goods and in the food and pharmaceutical or electronic sectors.

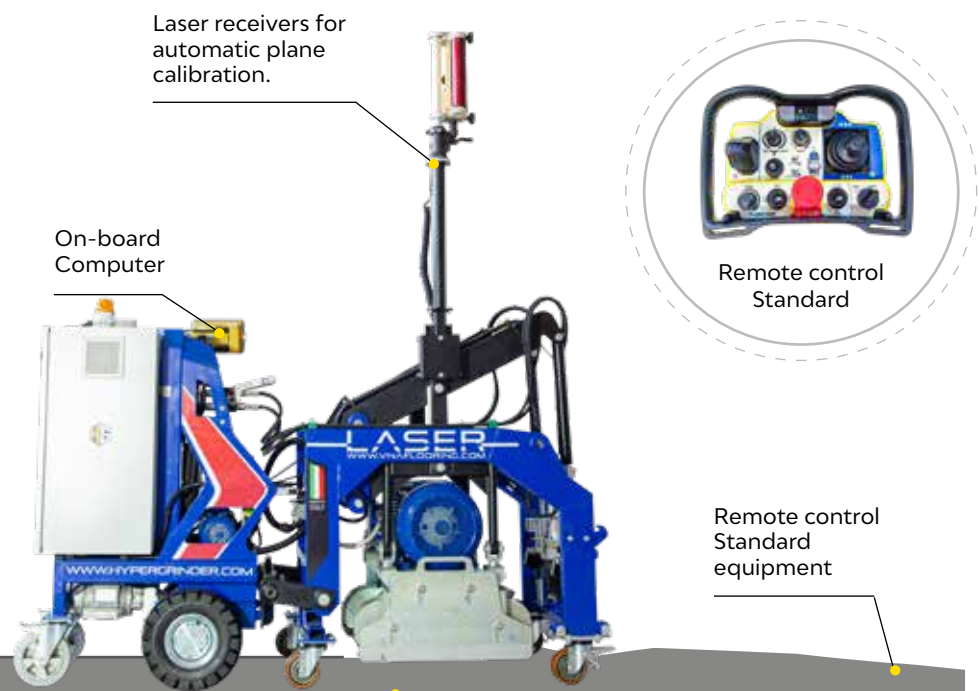

Perfectly planed floor after the planing process

# ULTRA FLAT FLOOR

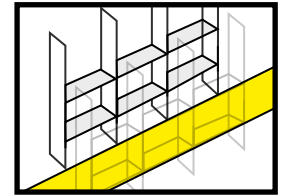

PERFECT FLATNESS

OF A LANE VNA



ART. HG170301



Ideal when the height difference between A and B =  $\pm 10\text{mm}$ , to create a perfect VNA lane.



## ESSENTIAL KIT FOR ULTRA-FLAT FLOOR CONFIGURATION



GROUP 1

+

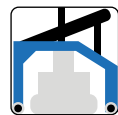

GROUP 2

+

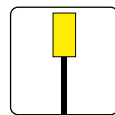

GROUP 8

+

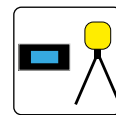

GROUP 5



### HG105203 - TRACTION GROUP

#### Main features:

- Electric traction: 0.75kW gearmotor r=1/230.
- Hydraulic power unit: 0.75kW motor pump.
- Electric drive only with cable, installed power 22kw.
- Complete with induction self-guiding kit.

GROUP 1



## GROUP 2

### HG149201 - COMPLETE SCARIFYING HEAD

**Main features:**

- Hydraulic actuators.
- Digital height display.
- Double extractor hood.
- Diamond roller, width max 400mm.
- 18.5Kw electric motor.



## GROUP 8

### HG168701 - SENSOR SUPPORT

- Support for receiving sensor.



## GROUP 5

### HG169101 - LASER TILT DRIVE + RECEIVER

**Complete with:**

- Control Panel
- Control panel support bracket
- Slope sensor
- Junction box
- Laser sensor
- Complete laser turret

## OPTIONAL KIT FOR FINE FINISHES

\*FOR ACHIEVING A SMOOTH AND POLISHED FINISH ACROSS THE ENTIRE SURFACE



## GROUP 3

### HG148302 - COMPLETE GRINDING HEAD

**Main features:**

- Hydraulic actuators.
- Digital height display.
- Extractor hood.
- 15kW electric motor.
- 750mm working section.
- 3 x 340mm tools.

# AUTOMATIC PLANER

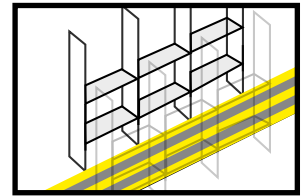

DOUBLE LANE

TWIN LANES

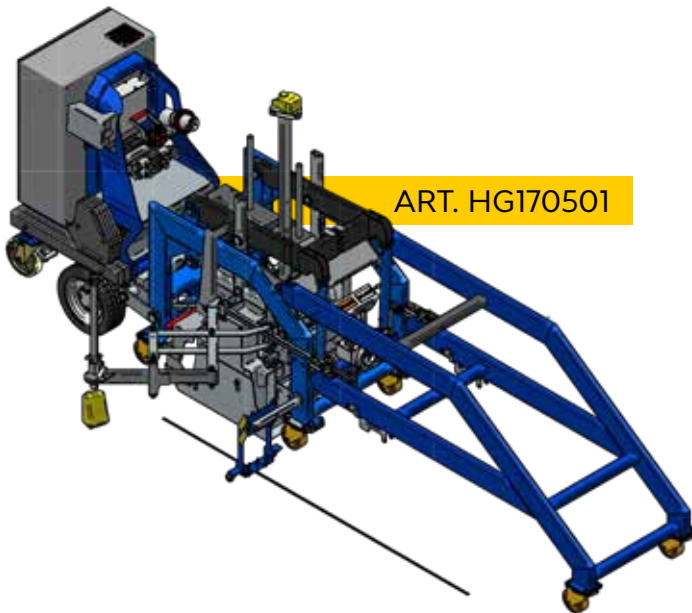

ART. HG170501



WITH THIS CONFIGURATION, THE MACHINE IS EQUIPPED TO ESTABLISH 'TWIN LANES' FOR VNA TROLLEYS.



ESSENTIAL COMPONENTS FOR AUTOMATED PLANING CONFIGURATION



GROUP 1

+



GROUP 2

+



GROUP 4

+

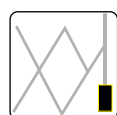

GROUP 9

+

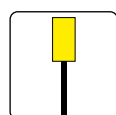

GROUP 6

**GROUP 1****HG105203 - TRACTION GROUP****Main features:**

- Electric traction: 0.75kW gearmotor r=1/230.
- Hydraulic power unit: 0.75kW motor pump.
- Electric drive only with cable, installed power 22kw.
- Complete with induction self-guiding kit.

**GROUP 2****HG149201 - COMPLETE SCARIFYING HEAD****Main features:**

- Hydraulic actuators.
- Digital height display.
- Double extractor hood.
- Diamond roller, width max 400mm.
- 18.5Kw electric motor.

**GROUP 4****HG148101 - PLANER ACCESSORY**

- Tip for mechanical and automatic planing.

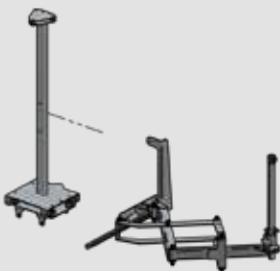
**GROUP 9****HG168601 - SUPPORT LINE COPY SENSOR**

- Touch probe holder.

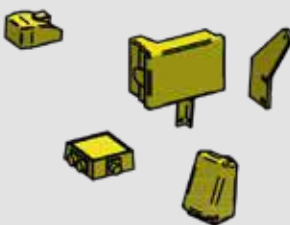
**GROUP 6****HG169201 - LASER DRIVE****Complete with:**

- Control Panel.
- Control panel support bracket.
- Slope sensor.
- Junction box.
- Probing sensor.

# MECHANICAL PLANER

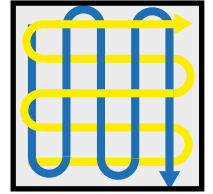

TO PLANE THE ENTIRE SURFACE  
AND CORRECT THE UNDULATIONS



ART. HG170401



THIS CONFIGURATION ENSURES PRECISE PLANING, RESULTING IN EXCEPTIONALLY  
FLAT SURFACES IN OPEN AREAS.

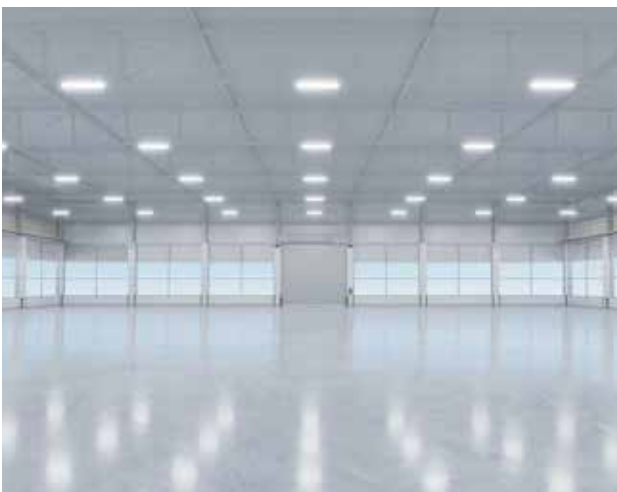



## ESSENTIAL KIT FOR MECHANICAL PLANING CONFIGURATION



+



+

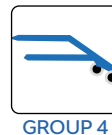

### GROUP 1



#### HG105203 - TRACTION GROUP

**Main features:**

- Electric traction: 0.75kW gearmotor r=1/230.
- Hydraulic power unit: 0.75kW motor pump.
- Electric drive only with cable, installed power 22kw.
- Complete with induction self-guiding kit.

### GROUP 2



#### HG149201 - COMPLETE SCARIFYING HEAD

**Main features:**

- Hydraulic actuators.
- Digital height display.
- Double extractor hood.
- Diamond roller, width max 400mm.
- 18.5Kw electric motor.

### GROUP 4



#### HG148101 - PLANER ACCESSORY

- Tip for mechanical and automatic planing.

## OPTIONAL KIT FOR FINE FINISHES

\*FOR ACHIEVING A SMOOTH AND POLISHED FINISH ACROSS THE ENTIRE SURFACE



### GROUP 3

#### HG148302 - COMPLETE GRINDING HEAD

**Main features:**

- Hydraulic actuators.
- Digital height display.
- Extractor hood.
- 15kW electric motor.
- 750mm working section.
- 3 x 340mm tools.

# 1 MACHINE 2 USES:

HYPER FLAT is equipped with two easily interchangeable tool heads:  
1- Planetary head with gear transmission.  
2- Milling head with roller or Multi-blade machine.



▲  
**TRACTION GROUP**

Connectable to the Planetary Head and the Milling Head.



▲  
**PLANETARY HEAD**

To get a smooth finish and remove the comb effect left by the milling head.



▲  
**MILLING HEAD**

Quick removal to get in a single step with the laser-calibrated plane.



## MAXIMUM FLEXIBILITY OF USE:

Excluding the laser system the HYPER FLAT FLOOR GRINDER is transformed into a radio-controlled floor grinder suitable for floor preparation or for concrete mirror polishing (HYPERCONCRETE®).

## FRAME FOR PLANING FLOORS.

Optional for manual leveling of the floor without the aid of the laser system. Quickly assembles on the front of the machine. Level the surface when using the laser method is too invasive or unnecessary.



## PLANING OF THE WHOLE LANE.

The exclusive process of the HYPER FLAT FLOOR Grinder allows planing for all the width of a corridor between two shelves. The HYPER FLAT FLOOR Grinder procedure covers all specifications for specific movements:

- Concrete Society TR34 (English area)
- Din 18 202
- Din 15 185 (German area)
- Fmin (US area)





## INCREASES THE EFFICIENCY OF THE WAREHOUSE.

With the exclusive HYPER FLAT FLOOR system you will get the highest possible flatness in the floor of your warehouse according to the highest standards and standards in force.

Having adequate flatness means obtaining the following advantages:

- HIGHER SPEED OF THE TROLLEYS.
- INCREASED WORK SAFETY.
- HIGHER EFFICIENCY.
- REDUCTION OF MAINTENANCE COSTS.
- BETTER QUALITY OF WORK.

The planing procedure uses sympathetic inclinations to improve the flatness of the floor, working according to the requirements of the specific request. It removes the minimum thickness possible to create the maximum benefit for the customer.

# FLOOR FLATNESS MEASURES

"A robotic measurement unit designed to enhance speed, ease, and productivity in your tasks. The integrated software provides a comprehensive toolkit for verifying distances, inclines, and angles on-site. Within a few simple steps, you're set to measure. Whether in low-light or well-lit conditions, targeting concealed points or spanning distances of up to 50 meters, the 3D Zoom boasts advanced features for precise targeting. A single button press, and your measurement is captured and displayed on-screen."

- SCAN THE AREA IN 3D
- IDENTIFY THE MOST CRITICAL POINTS
- IDENTIFY THE STARTING POINTS
- PREVENTIVE AND SUBSEQUENT CONTROL OF FLATNESS.

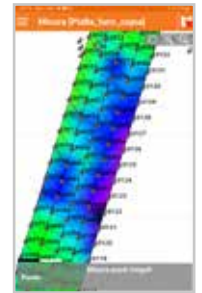

Easy to transport. With built-in batteries and reduced dimensions, the HYPER FLAT FLOOR can be easily transported with normal vans and does not require trucks or special vehicles.



**HYPER  
GRINDER**

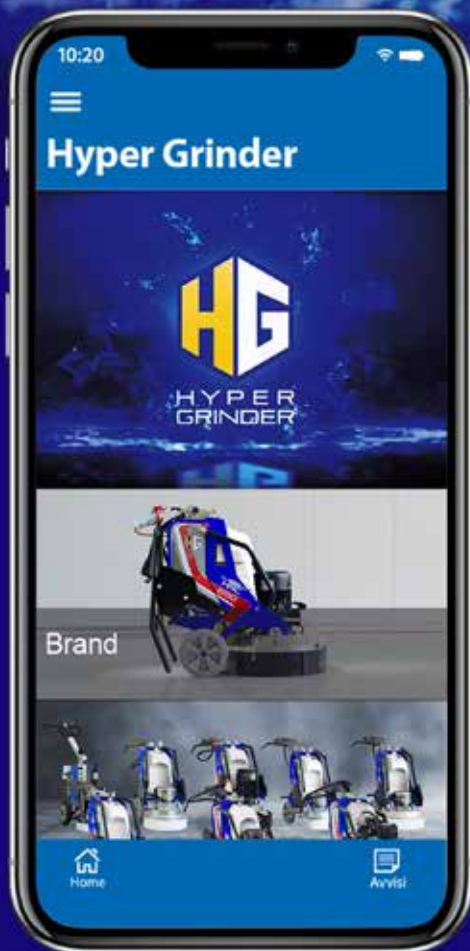

**DOWNLOAD  
THE APP**



**HG HYPER GRINDER S.R.L**  
Via Ragazzi del '99, 7 | 65123 Pescara (PE) | ITALY  
P.Iva 02223280682 | hypergrinder@pec.it | Tel +39 085 9218160  
[www.hypergrinder.com](http://www.hypergrinder.com) | [info@hypergrinder.com](mailto:info@hypergrinder.com)

Your Distributor: \_\_\_\_\_

SISTEMA DI GESTIONE  
QUALITÀ CERTIFICATO



UNI EN ISO 9001:2015



REV12092023